

13204

NISSAN ROGUE

4/10/2020

GROSS LOAD CAPACITY WHEN USED AS A WEIGHT CARRYING HITCH: 3,500 LBS. TRAILER WEIGHT & 525 LBS. TONGUE WEIGHT.

DO NOT EXCEED VEHICLE MANUFACTURER'S RECOMMENDED TOWING CAPACITY.

WARNING: ALL NON-TRAILER LOADS APPLIED TO THIS PRODUCT MUST BE SUPPORTED BY 18050 STABILIZING STRAPS.

** FAILURE TO PROPERLY SUPPORT NON-TRAILER LOADS WILL VOID PRODUCT WARRANTY **

HAVING INSTALLATION QUESTIONS? CALL TECHNICAL SUPPORT AT 1-877-287-8634

| Parts List | | | |
|------------|-----|-------------|----------------------------|
| ITEM | QTY | PART NUMBER | DESCRIPTION |
| 1 | 5 | 10-10275 | HHCS,M12x1.25,35,CL10.9,YZ |
| 2 | 5 | 30-00149 | WASHER,S-CON,1/2,YZ |

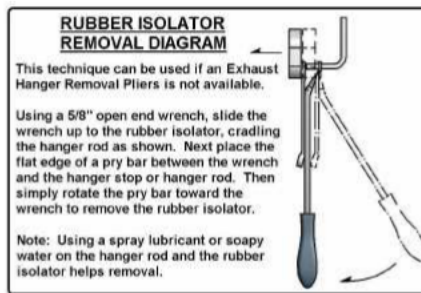
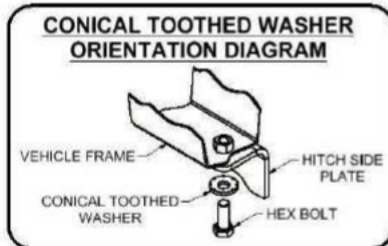

TOOLS REQUIRED

| |
|-----------------------------|
| 3/8" DRIVE RATCHET |
| 3/8" DRIVE 8" EXTENSION |
| 3/8" DRIVE TORQUE WRENCH |
| 8mm - 3/8" DRIVE SOCKET |
| 18mm - 3/8" DRIVE SOCKET |
| 19mm - 3/8" DRIVE SOCKET |
| FLAT & PHILLIPS SCREWDRIVER |
| WIRE PIPE BRUSH |
| SAFETY GLASSES |

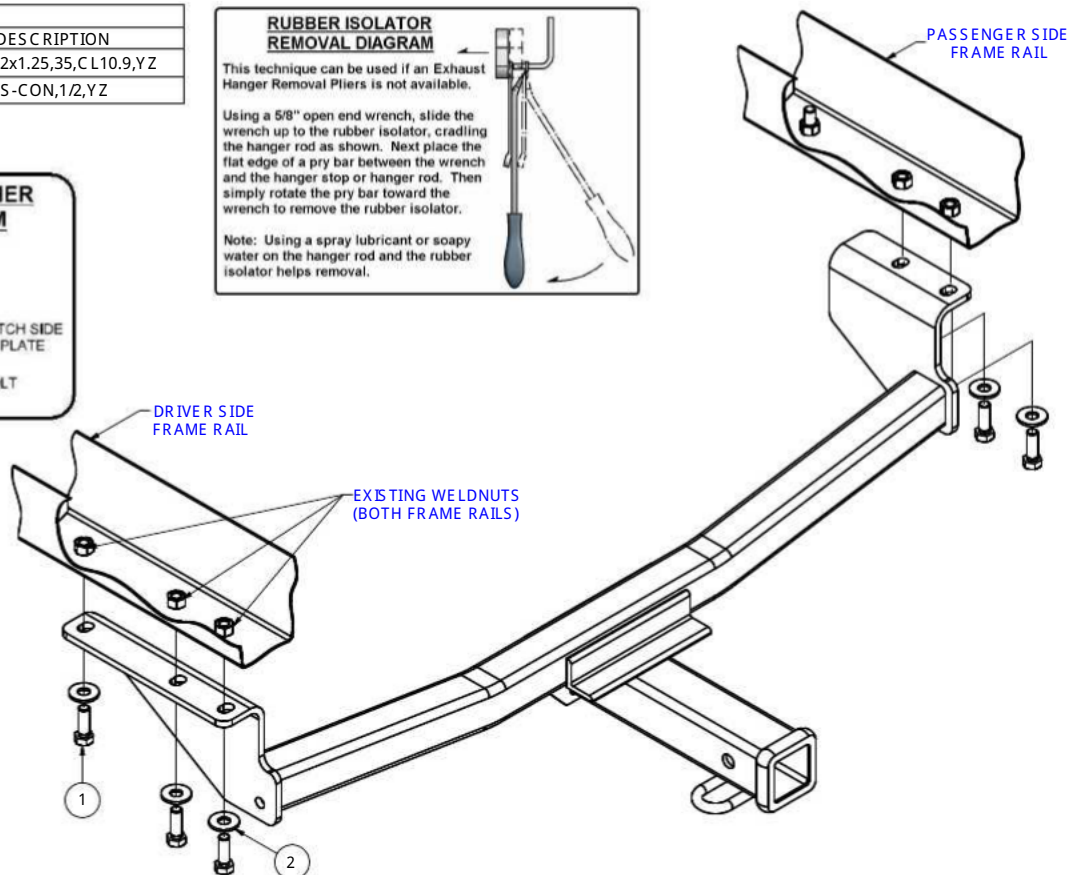

HITCH WEIGHT: 31 LBS.

INSTALL TIME

PROFESSIONAL: 30 MINUTES

NOVICE (DIY): 60 MINUTES

INSTALL NOTES:

- REMOVE TIE DOWN
- LOWER EXHAUST
- NO DRILLING
- REMOVE PANELS IF PRESENT

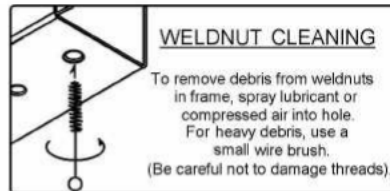

FRONT
↑
REAR

INSTALLATION STEPS

- 1) Remove lower underbody panels, if present, using a small screwdriver and phillips head screwdriver and return to vehicle owner.
- 2) Remove tow hook / bracket from the passenger side frame rail (4-5 bolts) and return to vehicle owner.
- 3) Lower exhaust for ease of installation.
- 4) Raise hitch into position and secure with hex bolts and conical washers as shown in the diagram above.
- 5) Torque all 12mm fasteners to 86 LB-FT.
- 6) Reinstall exhaust, if removed in step 3.

PERIODICALLY CHECK THIS RECEIVER HITCH TO ENSURE THAT ALL FASTENERS ARE TIGHT AND THAT ALL STRUCTURAL COMPONENTS ARE SOUND.



Scan
for more
information

CURT Manufacturing LLC., warrants this product to be free of defects in material and/or workmanship at the time of retail purchase by the original purchaser. If the product is found to be defective, CURT Manufacturing LLC., may repair or replace the product, at their option, when the product is returned, prepaid, with proof of purchase. Alteration to, misuse of, or improper installation of this product voids the warranty. CURT Manufacturing LLC.'s liability is limited to repair or replacement of products found to be defective, and specifically excludes liability for incidental or consequential loss or damage.



13204 INSTALLATION INSTRUCTIONS



Safety glasses should be worn at all times while installing this product.

YEARS: 2008-CURRENT

MAKE: NISSAN

MODEL: ROGUE (EXCLUDING KROM)

STYLE: S, SL, SV

WARNING: NEVER EXCEED YOUR VEHICLE MANUFACTURER'S RECOMMENDED TOWING CAPACITY







WEIGHT CARRYING: TRAILER WEIGHT: 3,500 LBS.
TONGUE WEIGHT: 525 LBS.

WARNING: WE RECOMMEND THE USE OF 18050 STABILIZING STRAPS FOR ALL NON-TRAILER (WHEEL-LESS) LOADS. PLEASE SEE THE CURT CATALOG OR VISIT US ONLINE AT WWW.CURTMFG.COM FOR FURTHER INFORMATION.

PRO INSTALL TIME: 30 MIN.
NOVICE INSTALL TIME: 60 MIN.

IF YOU ARE HESITANT TO UNDERTAKE THIS TASK ON YOUR OWN, CONTACT AN AUTHORIZED CURT INSTALLER FOR ADDITIONAL ASSISTANCE.







INSTALLATION REQUIRES:

| | | |
|---|--|---|
|  8mm 18mm 19mm SOCKET |  RATCHET |  8" SOCKET EXTENSION |
|  TORQUE WRENCH |  WIRE PIPE BRUSH |  SCREW DRIVER |
|  SAFETY GLASSES | | |
| | | |

INSTALLATION TIPS:

- BEFORE YOU BEGIN INSTALLATION, READ ALL INSTRUCTIONS THOROUGHLY.
- TO EASE INSTALLATION, 2 PEOPLE MAY BE REQUIRED.
- USING PROPER TOOLS WILL GREATLY IMPROVE THE QUALITY OF THE INSTALL AND REDUCE THE TIME REQUIRED.
- NEED HELP OR HAVE SOME QUESTIONS? CALL TECHNICAL SUPPORT AT 877.287.8634

LEVEL OF DIFFICULTY: EASY

| | | |
|---|--|---|
|  |  |  |
|  | NO DRILLING REQUIRED | |
|  | REMOVE HEAT SHIELD, UNDERBODY PANELS, AND TOW HOOK | |
|  | LOWER EXHAUST TO EASE INSTALLATION | |
| | | |
| | | |

VEHICLE PHOTO:



REPRESENTATIVE PHOTO

HITCH ILLUSTRATION:

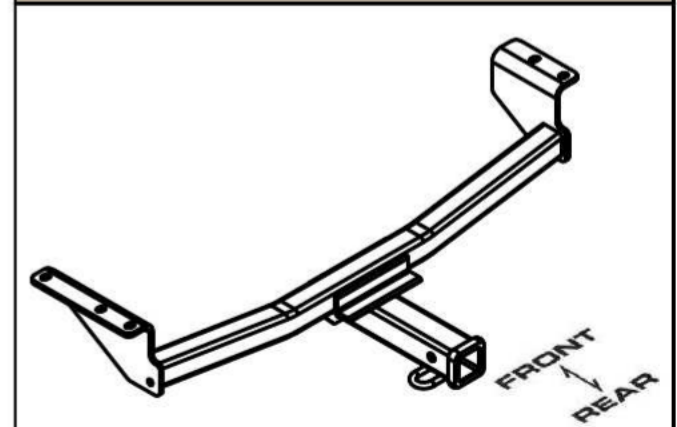

MAKE SURE YOUR HITCH MATCHES



PERIODICALLY CHECK THIS RECEIVER HITCH TO ENSURE ALL FASTENERS ARE TIGHT AND ALL STRUCTURAL COMPONENTS ARE SOUND
CURT Manufacturing LLC. warrants this product to be free of defects in material and/or workmanship at the time of retail purchase by the original purchaser. If the product is found to be defective, CURT Manufacturing LLC. may repair or replace the product at their option, when the product is returned, prepaid, with proof of purchase. Alteration to, misuse of, or improper installation of this product voids the warranty. CURT Manufacturing LLC.'s liability is limited to repair or replacement of products found to be defective, and specifically excludes liability for incidental or consequential loss or damage. For more information log onto www.curtmfg.com, & for helpful towing tips log onto www.hitinfo.com